



2023/03
FİYAT LİSTESİ

nts

nts.com.tr

Akıllı Ev Sistemleri

7" Dokunmatik,
Uzaktan Erişimli

6.750 ₺



Sensörler Güç Kaynağı

775 ₺



Akıllı Ev Ana Modülü

3.780 ₺



Akıllı Ev Güç Kaynağı

1.710 ₺

AYDINLATMA & PANJUR MODÜLLERİ

ROLELİ

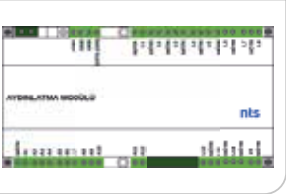

4'lü

4.500 ₺

8'li

9.000 ₺

12'li

13.500 ₺



2'li

4.500 ₺

4'lü

9.000 ₺

6'li

13.500 ₺

RF'Lİ

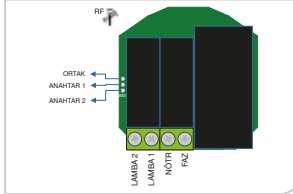

Aydınlatma Modülü

1.725 ₺

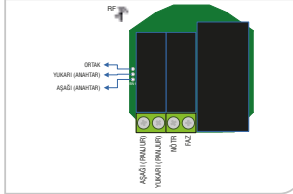

Panjur Modülü

1.725 ₺

ALARM SENSÖRLERİ

ATP-546
715 ₺TSD-701
1.650 ₺TSD-5124
1.360 ₺TOD-0590
675 ₺VAS-741BP
4.425 ₺

VANALAR

Gaz Vanası
1.500 ₺Su Vanası
9.000 ₺

IP İnterkom Sistemleri

IP İnterkomları

| | | |
|---|---|--|
|  | <p>NTS 9002</p> <p>₺4.290</p> | <p>HD Görüntü Kalitesi Yüksek konuşma ses kalitesi Daireler ve bloklar arası görüşme Güvenlik birimi ile görüşme Sınırsız daire ve blok bağlayabilme Alarm altyapısı (Yangın,su,gaz dedektörleri) SOS acil durum Fotoğraf çekebilme Linux işletim sistemi Mesaj alma özelliği 7" kapasitif dokunmatik ekran Çevre IP kamera bağlayabilme Asansör çağırma</p> |
|---|---|--|

IP Kameralı Zil Panosu

| | | |
|---|--|---|
|  | <p>NTS 9003</p> <p>₺12.780</p> | <p>2 Megapixel HD kamera 7" dokunmatik ekran Kamera görüş açısı ayarı Kart tanımalı geçiş İsim listesi Güvenlik ile görüşme Android işletim sistemi</p> |
| | <p>NTS 9004 "Yüz tanıma geçişi"</p> <p>₺19.800</p> | |

Tamamlayıcı Aksamlar



Güvenlik Konsolu
NTS 9001

₺15.480

6+2 POE Switch
NTS 9006

₺2.140

Görüntülü Diafon Sistemleri

4.3" renkli görüntülü diafonlar

**NTS 2001-S**

Boyut 100x180x18 mm
Ekran çözünürlüğü 480x270
Ekran ölçüsü 54x97 mm

₺1.370**NTS 2001-B**

Boyut 100x180x18 mm
Ekran çözünürlüğü 480x270
Ekran ölçüsü 54x97 mm

₺1.370**NTS 2004-S**

Boyut 100x180x18 mm
Ekran çözünürlüğü 480x270
Ekran ölçüsü 54x97 mm

₺1.840**NTS 2004-B**

Boyut 100x180x18 mm
Ekran çözünürlüğü 480x270
Ekran ölçüsü 54x97 mm

₺1.840

Görüntülü Diafon Sistemleri

7" renkli görüntülü diafonlar

**NTS 2015-B**

Boyut 135x205x28 mm
Ekran çözünürlüğü 800x480
Ekran ölçüsü 87x156 mm

₺2.065**NTS 2015-S**

Boyut 135x205x28 mm
Ekran çözünürlüğü 800x480
Ekran ölçüsü 87x156 mm

₺2.065Sesli diafonlar **(ZİL DÖNÜŞSÜZ)****NTS 2019****₺810**

10 Melodi zil seçeneği, rahatsız edilmeme

Görüntülü Diafon Sistemleri

Kameralı zil panoları

7" DOKUNMATİK



NTS 8006

Kameralı, 7" dokunmatik ekranlı, kart geçiřli, zil panosu.

Boyutlar: 150x360x60mm
(Düz sıva üstü aparatı içindedir.)

₺ 14.900



NTS 8004

Kameralı, kart geçiřli, tuř takımlı zil panosu

Boyutlar: 112x330x20 mm

₺ 4.770



NTS 8003 NTS 8003-S

Kameralı tuř takımlı zil panosu

Boyutlar: 112x 286x20 mm

₺ 4.285



NTS 8001-2 NTS 8001-4

Kameralı butonlu zil panoları

112x230x20 mm

112x286x20 mm

₺ 3.375

₺ 3.500

Sıva üstü zil panosu aparatları



Alüminyum düz altlık

| | | |
|------------|----------------|---------|
| NTS 2016-3 | 8003,8001-4 | ₺ 1.440 |
| NTS 2016-5 | 8001-1, 8001-2 | |
| NTS 2016-8 | 8004 | |
| NTS 2016-9 | 8005 | |



45 ° Çevirme aparatı

| | | |
|------------|----------------|---------|
| NTS 2016 | 8003,8001-4 | ₺ 1.260 |
| NTS 2016-4 | 8001-1, 8001-2 | |
| NTS 2016-7 | 8004 | |
| | | |



Pleksi ışıklık

| | | |
|------------|--------------|---------|
| NTS 3886 | 8003, 8001-4 | ₺ 1.710 |
| NTS 3886-1 | 8004 | |
| | | |

Görüntülü Diafon Sistemleri

Görüntülü sistem parçaları ve aksesuarları

| | | | | |
|---|---|---|---|---|
|  |  |  |  |  |
| NTS 9063/ ₺ 850 | NTS 9081/ ₺ 670 | NTS 9087/ ₺ 235 | NTS 9064/ ₺ 3.420 | NTS 2017/ ₺ 330 |
| Sistem beslemesi 100x130x40 mm | Video yükselticisi 55x85x75 mm | Video dağıtıcısı 55x57x20 mm | Güvenlik konsolu 202x282x135 mm | Büyük isimlik 240x330x18 mm |

Görüntülü sistem paket fiyat listesi

4.3"



| NTS 2001-B | |
|------------|----------|
| DS | Fiyat |
| 1 | ₺ 6.505 |
| 2 | ₺ 7.875 |
| 3 | ₺ 9.245 |
| 4 | ₺ 10.615 |
| 5 | ₺ 11.985 |
| 6 | ₺ 13.355 |
| 7 | ₺ 14.725 |
| 8 | ₺ 16.095 |
| 9 | ₺ 17.465 |
| 10 | ₺ 19.505 |
| 11 | ₺ 20.875 |
| 12 | ₺ 22.245 |
| 13 | ₺ 23.615 |
| 14 | ₺ 24.985 |
| 15 | ₺ 26.355 |
| 16 | ₺ 27.725 |
| 17 | ₺ 29.095 |
| 18 | ₺ 30.465 |
| 19 | ₺ 31.835 |
| 20 | ₺ 33.205 |
| 21 | ₺ 34.575 |
| 22 | ₺ 35.945 |
| 23 | ₺ 37.315 |
| 24 | ₺ 38.685 |
| 25 | ₺ 40.055 |

7"



| NTS 2015-B | |
|------------|----------|
| DS | Fiyat |
| 1 | ₺ 7.200 |
| 2 | ₺ 9.265 |
| 3 | ₺ 11.330 |
| 4 | ₺ 13.395 |
| 5 | ₺ 15.460 |
| 6 | ₺ 17.525 |
| 7 | ₺ 19.590 |
| 8 | ₺ 21.655 |
| 9 | ₺ 23.720 |
| 10 | ₺ 26.455 |
| 11 | ₺ 28.520 |
| 12 | ₺ 30.585 |
| 13 | ₺ 32.650 |
| 14 | ₺ 34.715 |
| 15 | ₺ 36.780 |
| 16 | ₺ 38.845 |
| 17 | ₺ 40.910 |
| 18 | ₺ 42.975 |
| 19 | ₺ 45.040 |
| 20 | ₺ 47.105 |
| 21 | ₺ 49.170 |
| 22 | ₺ 51.235 |
| 23 | ₺ 53.300 |
| 24 | ₺ 55.365 |
| 25 | ₺ 57.430 |

**Satış Yapılırken Dikkat Edilmesi Gerekenler,**

- Sistemde buat sayısı kadar NTS 9087 (Video dağıtıcı) kullanılmalıdır. (Paket listede bulunmamaktadır.)

- 10 Daire ve sonrasında NTS 9081 (Video yükseltici) paket listede bulunmaktadır.

- Düz altlık veya çevirme aparatı kullanılmasını tavsiye ederiz. Sıva üstü olması kolay montaj sağlar, panelin ömrünü uzatır. (Paket listede bulunmamaktadır.)

- Güvenlik bulunan projeler özel sipariş verilmelidir.

Kapı geçiş sistemleri

| | |
|---|---|
|  | NTS 9070 / 570x120x20 mm / ₺ 1900 |
| | Hem kartlı, hem şifreli geçiş konsolu 250 kullanıcıya kadar şifre ve kart belirleme, şifre ile kapı açma, programlama şifresi değiştirme, açma-kapama süresini değiştirme |

| | |
|---|-----------------|
|  | NTS 9074 / ₺ 21 |
| | Anahtarlı geçiş |

Görüntülü Diafon Sistemleri

Görüntülü villa kitler paket fiyat listesi

4.3"

| | | |
|---|--------------------------|---------------|
| Villa kit paket fiyatı ₺5.235 | | |
| NTS 2001-B | 4.3" Görüntülü diafon | ₺1.370 |
| NTS 8001-1 | Kameralı zil panosu | ₺3.015 |
| NTS 9063 | Villa kit beslemesi | ₺850 |

NTS 8001-1
112x230x20 mmNTS 2016-5
Villa kit zil panosu
düz altlıkNTS 2016-4
Villa kit zil panosu
45° çevirme aparatı

7"

| | | |
|---|------------------------|---------------|
| Villa kit paket fiyatı ₺5.930 | | |
| NTS 2015-B | 7" Görüntülü diafon | ₺2.065 |
| NTS 8001-1 | Kameralı zil panosu | ₺3.015 |
| NTS 9063 | Villa kit beslemesi | ₺850 |

NTS 8001-1
112x230x20 mmSıva üstü villa kit
zil paneli aparatları

| | | |
|---------------|------------------------|---------------|
| NTS 2016-4 | 45° çevirme aparatu | ₺1.260 |
| NTS 2016-5 | Düz altlık | ₺1.440 |

Bağlantı Şemaları

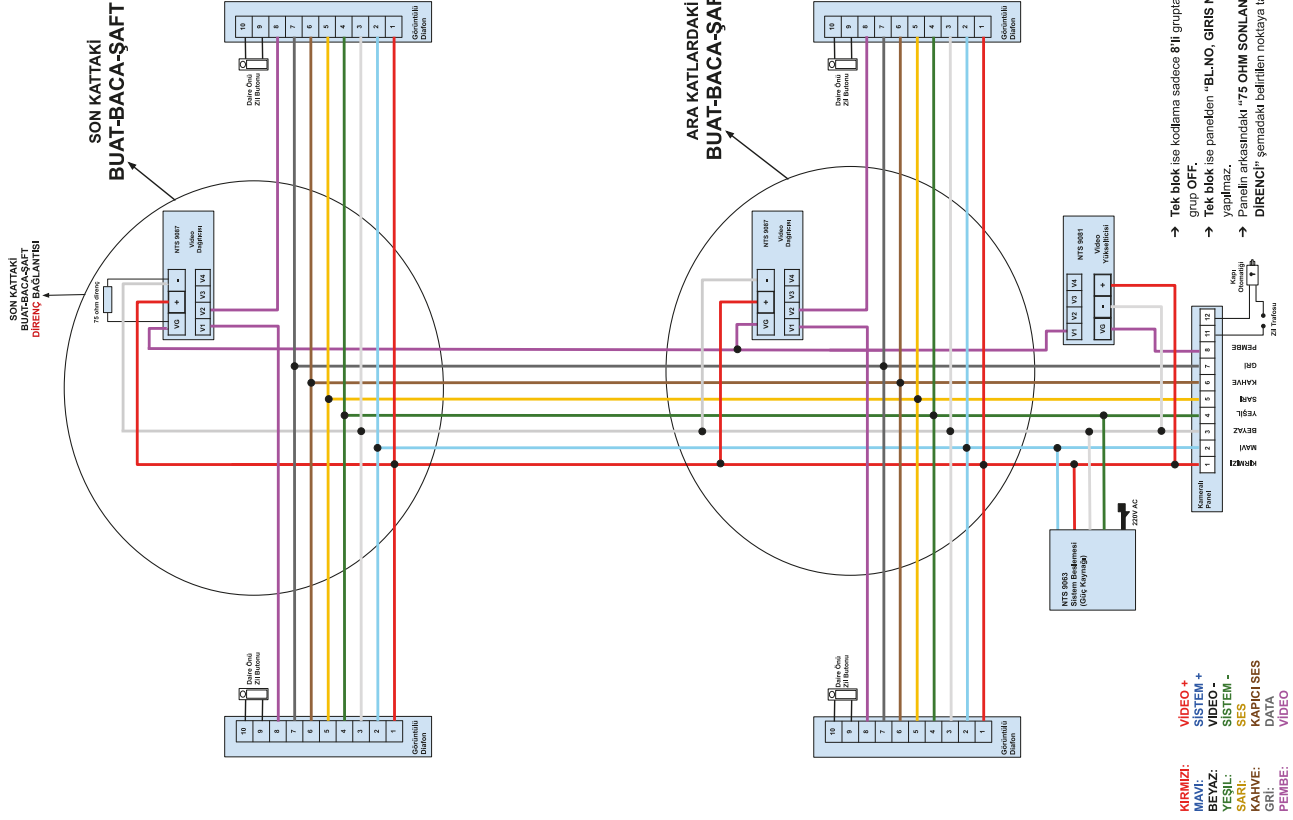
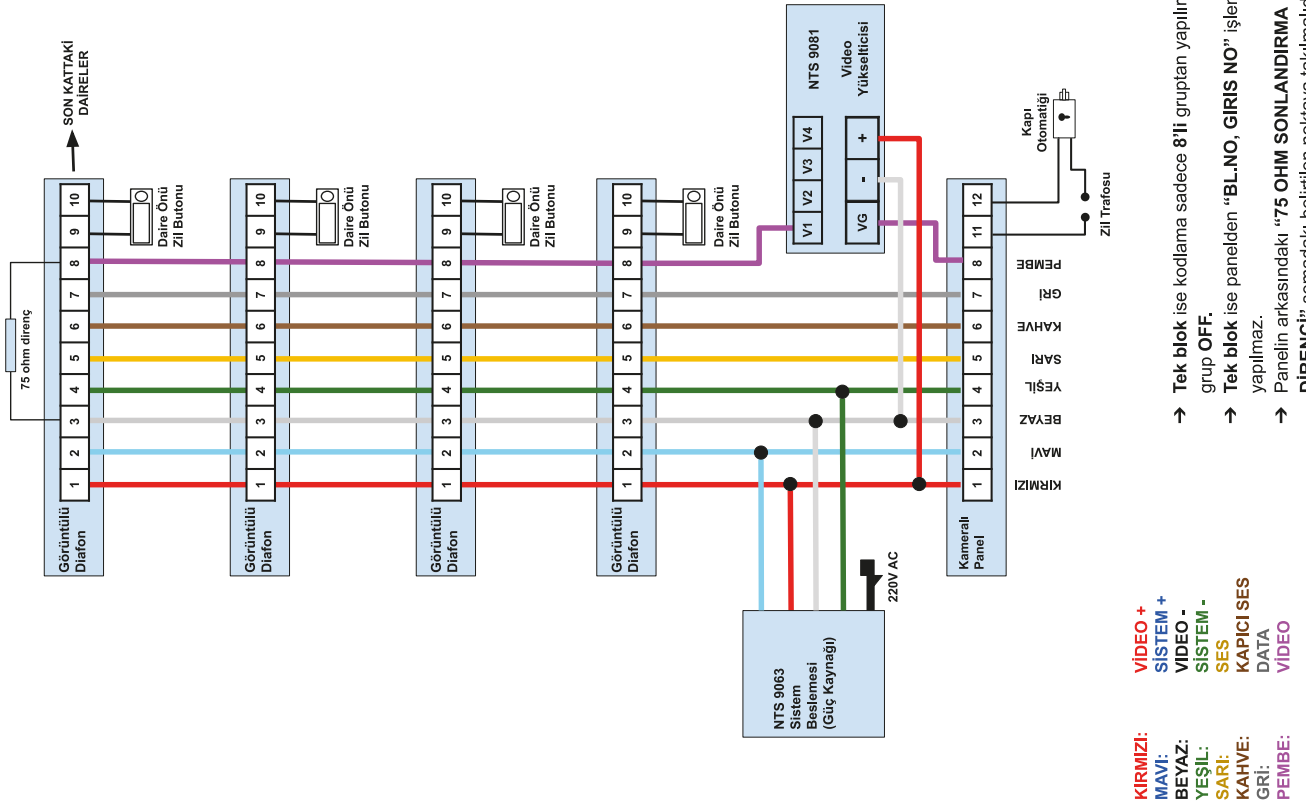
GÖRÜNTÜLÜ DIAFON
BUAT-BACA-ŞAFT
BAĞLANTI ŞEMASIGÖRÜNTÜLÜ DIAFON
KATTAN KATA - DAİREDEN DAİREYE
BAĞLANTI ŞEMASI

Sesli Diafon Sistemleri

Pandora serisi sesli daire içi diafonlar



| | | |
|--|----------|---------|
| | NTS 4001 | ₺ 880 |
| | NTS 4002 | ₺ 980 |
| | NTS 4003 | ₺ 1.080 |
| | NTS 4004 | ₺ 1.180 |
| | NTS 4005 | ₺ 1.280 |
| | NTS 4006 | ₺ 1.380 |
| | NTS 4007 | ₺ 1.480 |
| | NTS 4008 | ₺ 1.580 |
| | NTS 4009 | ₺ 1.680 |
| | NTS 4010 | ₺ 1.780 |
| | NTS 4011 | ₺ 1.880 |
| | NTS 4012 | ₺ 1.980 |

| | | |
|--|-------------|---------|
| | NTS 4001-2 | ₺ 715 |
| | NTS 4003-4 | ₺ 830 |
| | NTS 4005-6 | ₺ 945 |
| | NTS 4007-8 | ₺ 1.060 |
| | NTS 4009-10 | ₺ 1.175 |
| | NTS 4011-12 | ₺ 1.290 |
| | NTS 4013-14 | ₺ 1.405 |
| | NTS 4015-16 | ₺ 1.520 |
| | NTS 4017-18 | ₺ 1.635 |
| | NTS 4019-20 | ₺ 1.750 |
| | NTS 4021-22 | ₺ 1.865 |
| | NTS 4023-24 | ₺ 1.980 |
| | NTS 4025-26 | ₺ 2.095 |
| | NTS 4027-28 | ₺ 2.210 |
| | NTS 4029-30 | ₺ 2.325 |
| | NTS 4031-32 | ₺ 2.440 |

Pandora serisi paket fiyat listesi

| Pandora NTS 3003 | DS | Fiyat | Paket listesi için zil panoları çift sıralı, çift zilli, bir girişe göre hesaplanmıştır. |
|------------------|----|---------|--|
| | 1 | ₺ 3.015 | |
| | 2 | ₺ 3.315 | |
| | 3 | ₺ 3.730 | |
| | 4 | ₺ 4.030 | |
| | 5 | ₺ 4.445 | |
| | 6 | ₺ 4.745 | |
| | 7 | ₺ 5.160 | |
| | 8 | ₺ 5.460 | |
| | 9 | ₺ 5.875 | |
| | 10 | ₺ 6.175 | |
| | 11 | ₺ 6.590 | |
| | 12 | ₺ 6.890 | |
| | 13 | ₺ 7.305 | |
| | 14 | ₺ 7.605 | |
| | 15 | ₺ 8.020 | |
| | 16 | ₺ 8.320 | |
| | 17 | ₺ 8.735 | |
| | 18 | ₺ 9.035 | |
| | 19 | ₺ 9.450 | |
| | 20 | ₺ 9.750 | |



Tamamen **Yerli**
Tamamen **Milli**

NTS olarak,
yerli tasarım, yerli yazılım
ve yerli sermaye ile
üretim yaparak
ülkemizin geleceğine
katkıda bulunmaktan
gurur duyuyoruz

nts

nts.com.tr

Adres : Fevzi Çakmak Mah. Ayyıldız Cad.
No: 18/B - Karatay / KONYA
Web : www.nts.com.tr

Tel : 0332 345 46 56
Fax : 0332 354 02 62
Mail : nts@nts.com.tr